

Auto Fuse

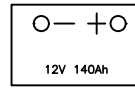

Battery



Steam Light



Circuit breaker



Port Nav Light



Alternator



Starboard Nav Light



Start Motor



Aft Nav. Light

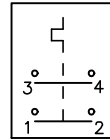

230V Auto Fuse



3-Colour Light



Anchor Light



230V Outlet



Deck Light



Earth



Compass Light



Connection Box



Light with Switch (Wardrobe etc.)



Light with Switch (Gold Lamp)



Light (Ceiling)



Switch



Light (Meta List)



Low Current Outlet (12V or 24V)

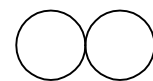

Marked Cable = Negative

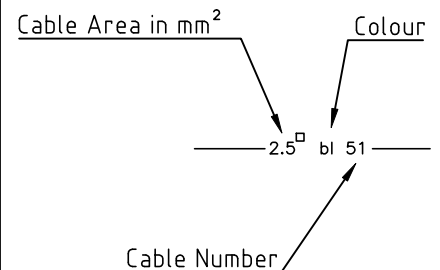
**Colours:**

w = white  
 b = black  
 r = red  
 gr = grey  
 gn = green  
 y = yellow  
 vi = violett  
 or = orange  
 bl = blue  
 bn = brown  
 tr = transparent



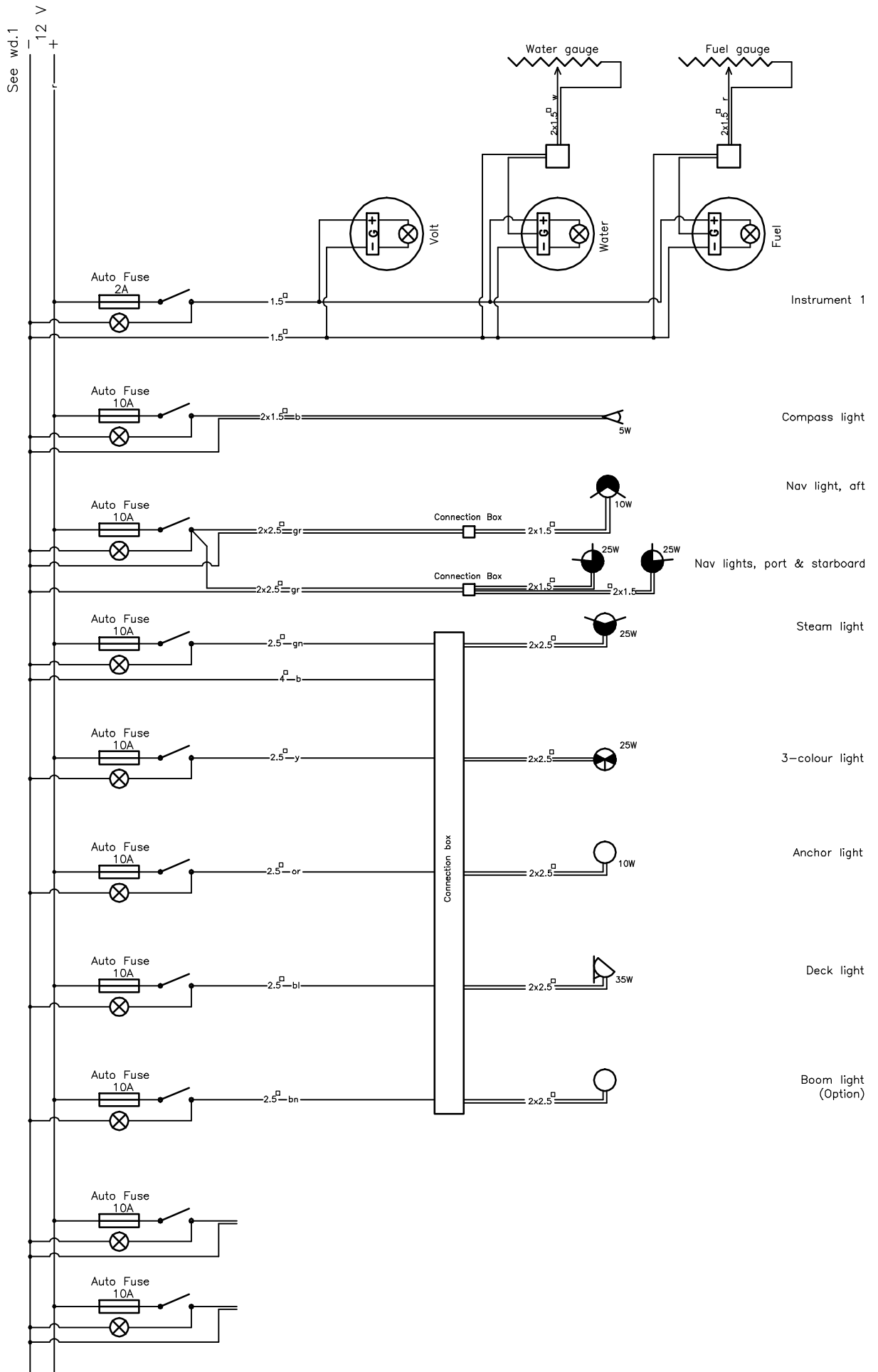

Wiring diagram

HR 43



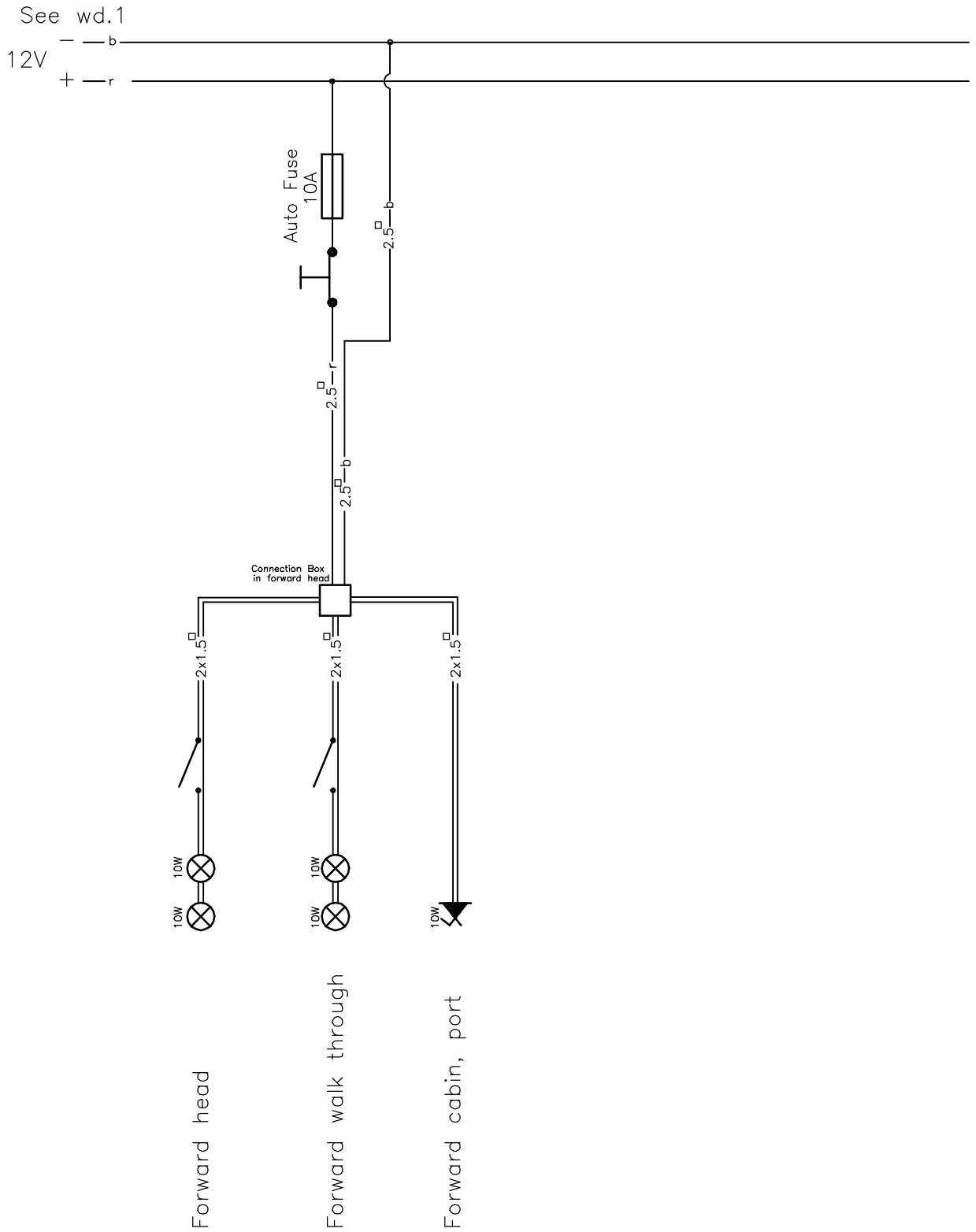

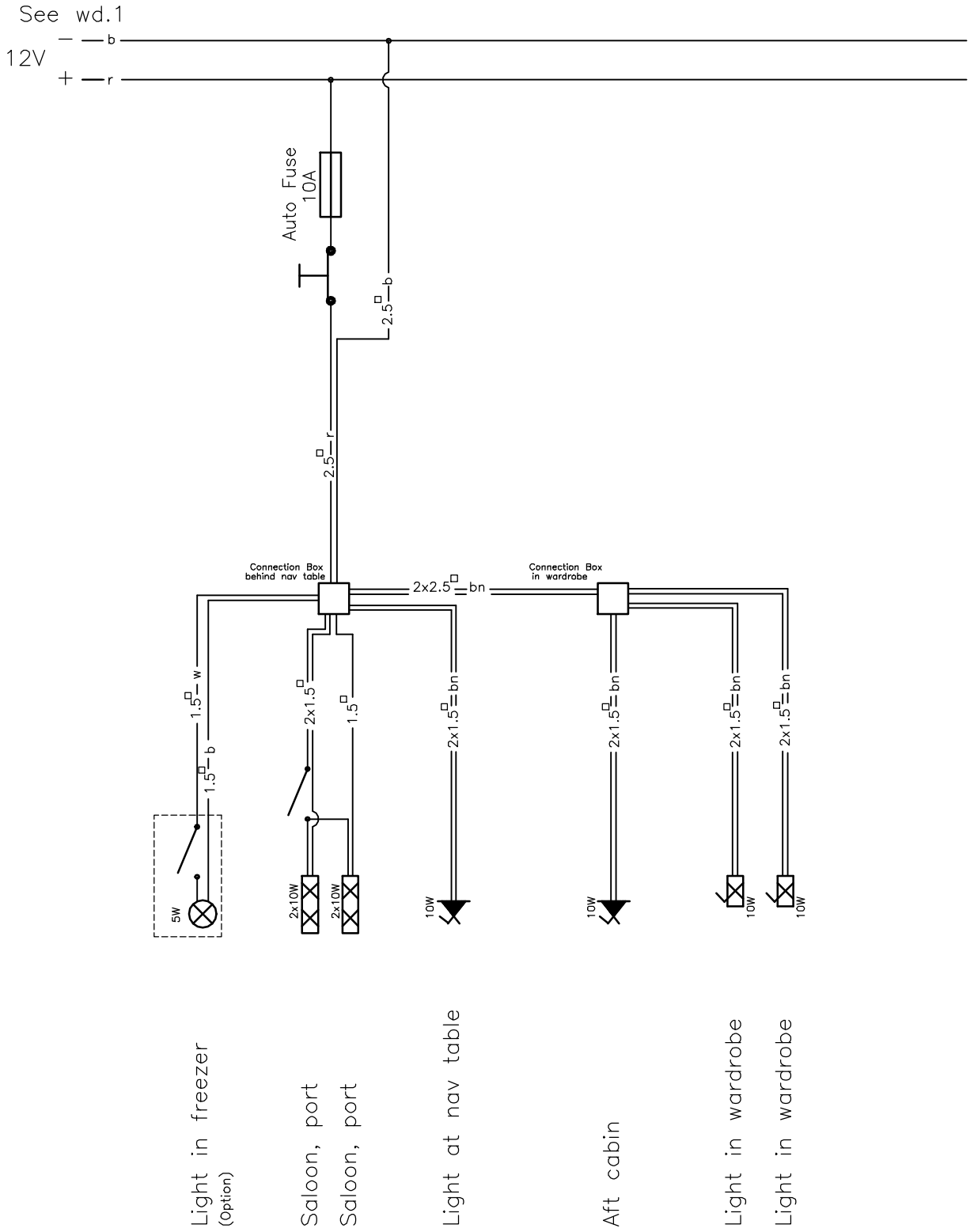

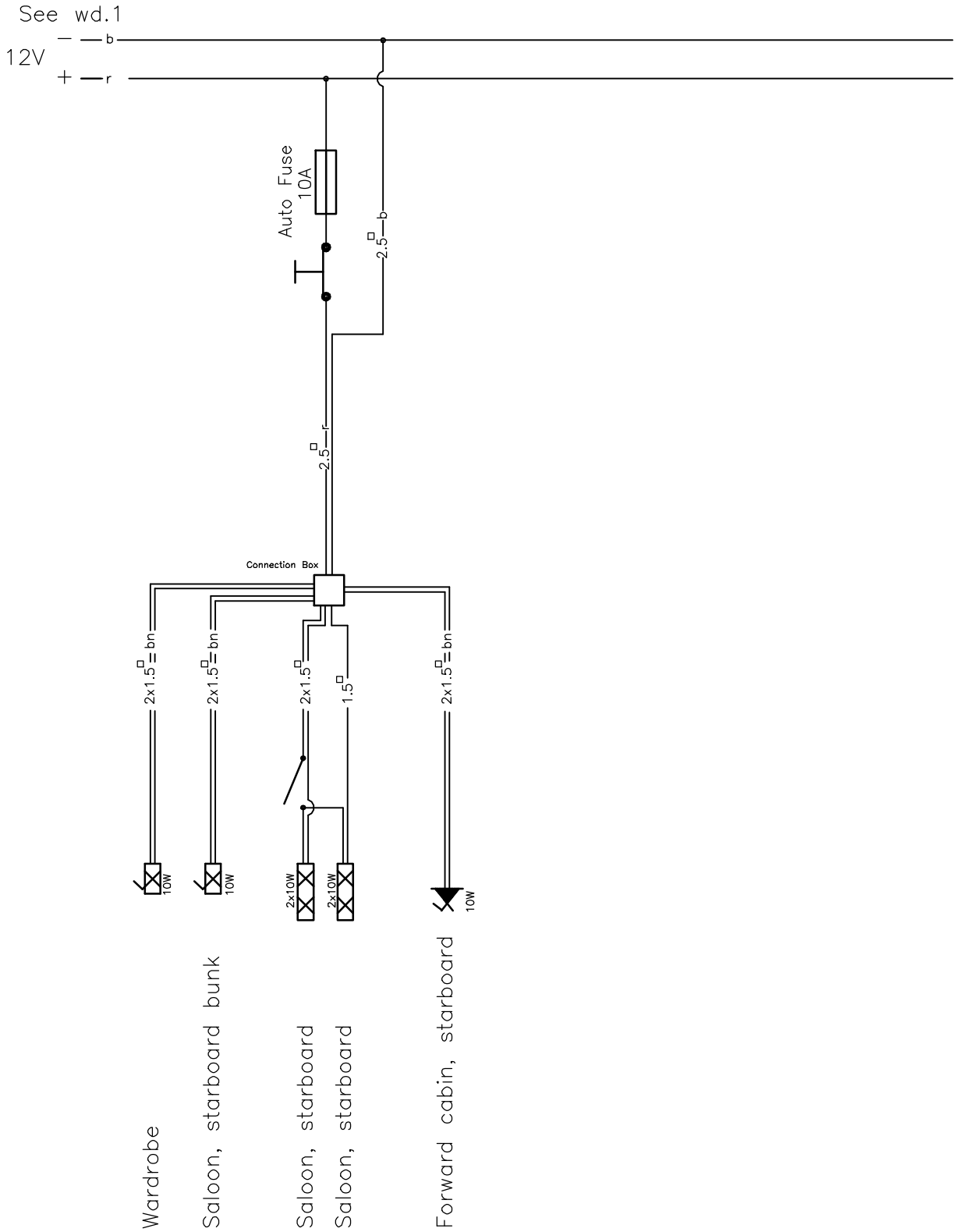

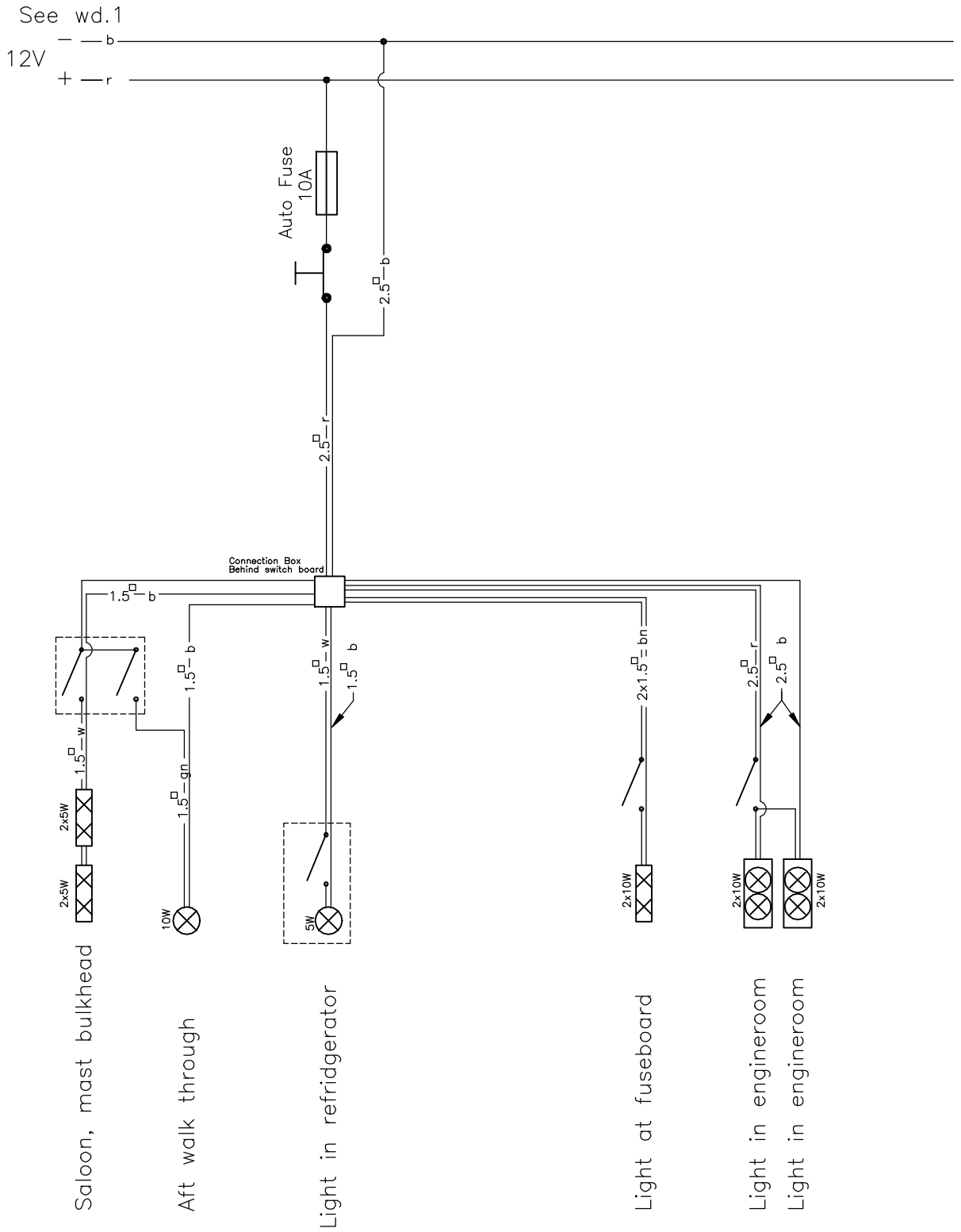



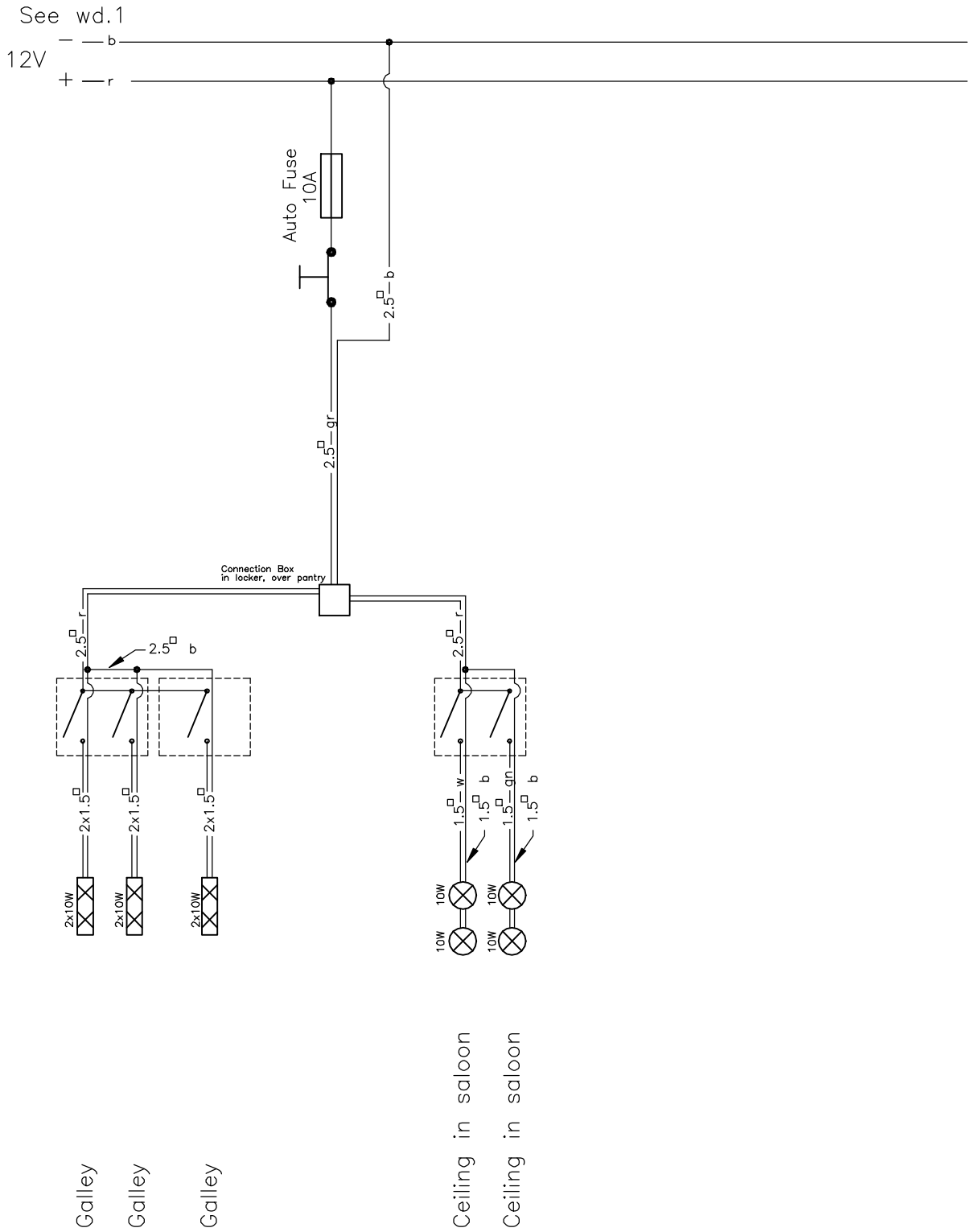

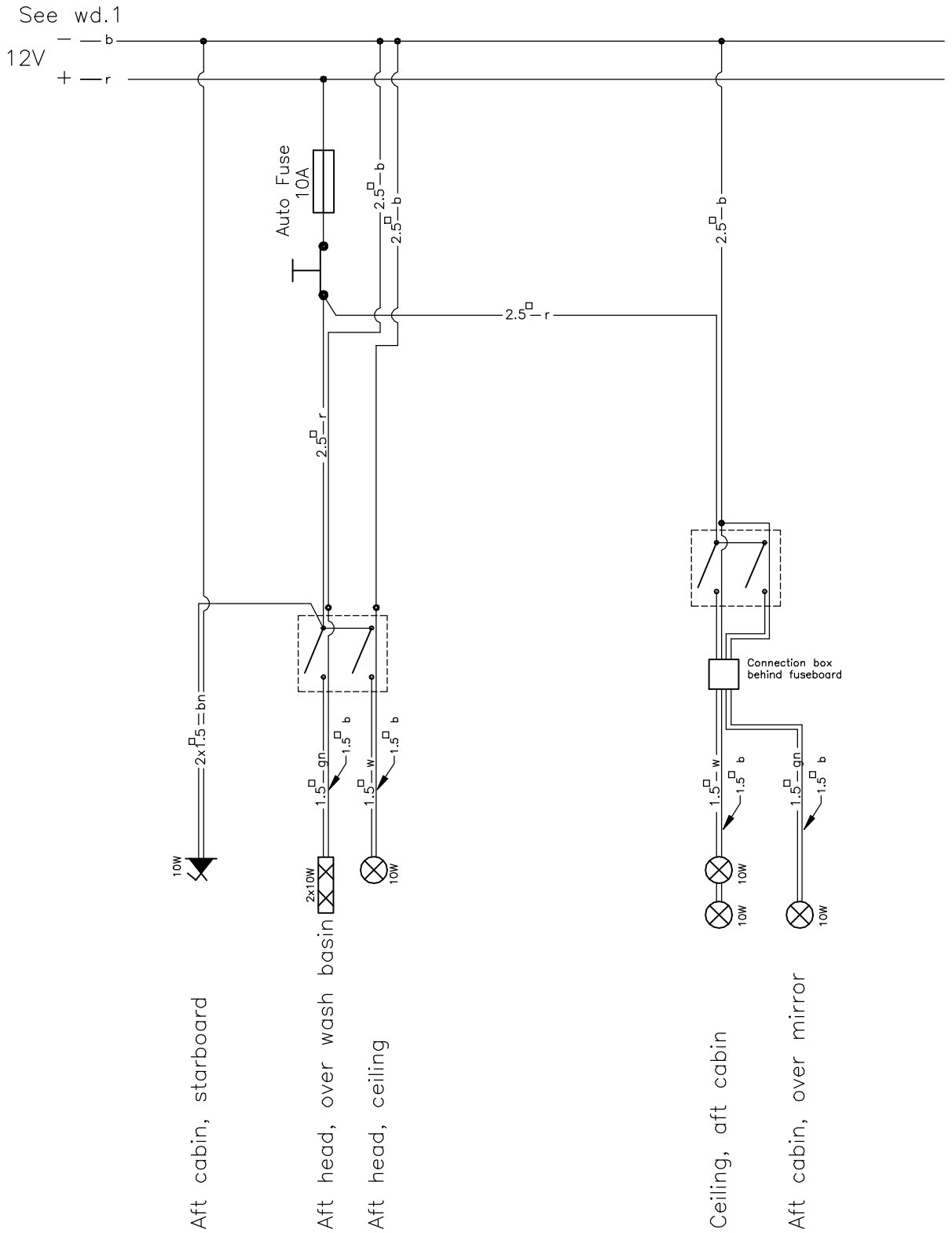

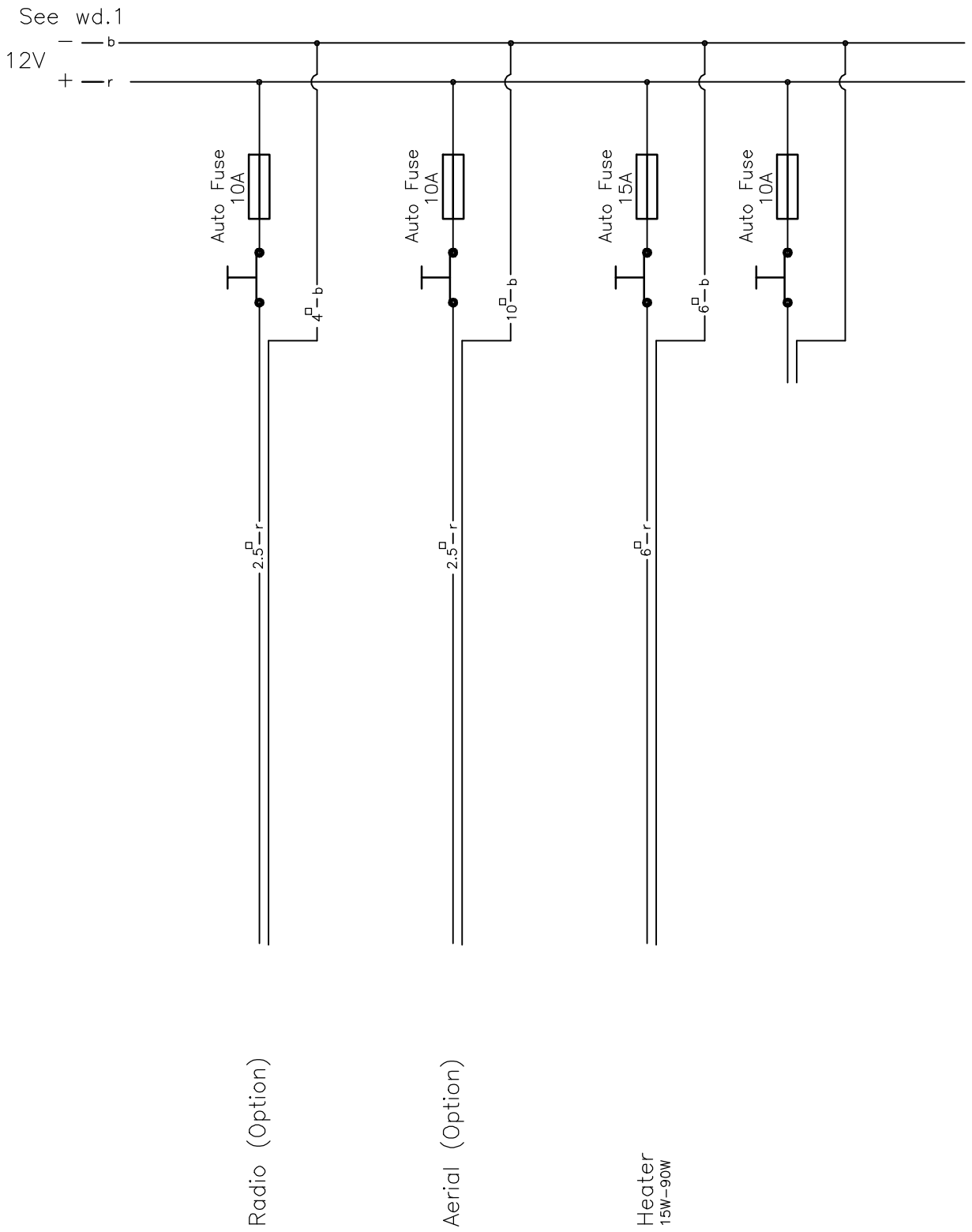



See wd.1

Continuous

12V  
 - b  
 + r

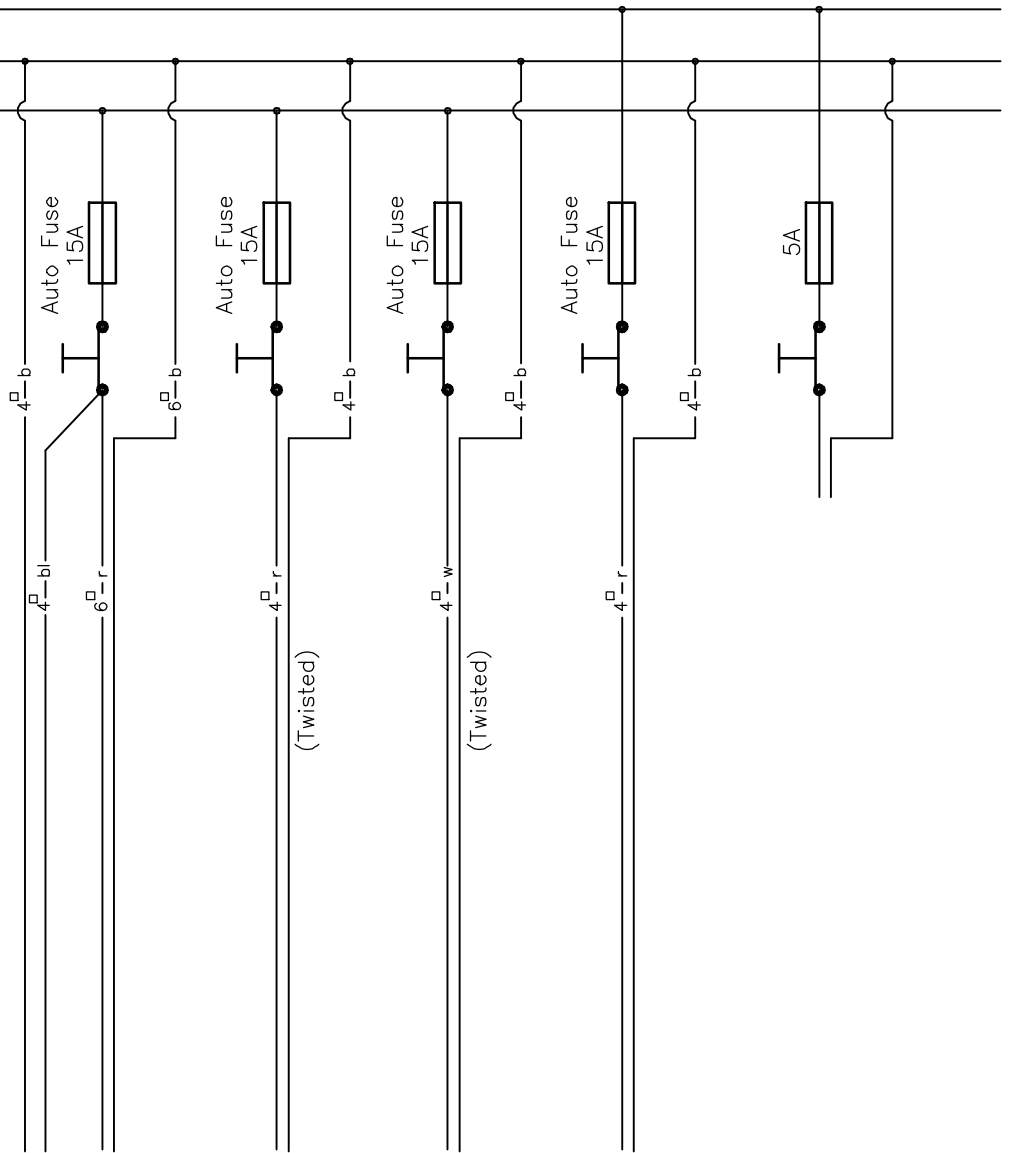

12V Outlet in cockpit

12V Outlet in fuseboard

Refrigerator  
 72W

Freezer  
 (option)

Radio memory (Option)

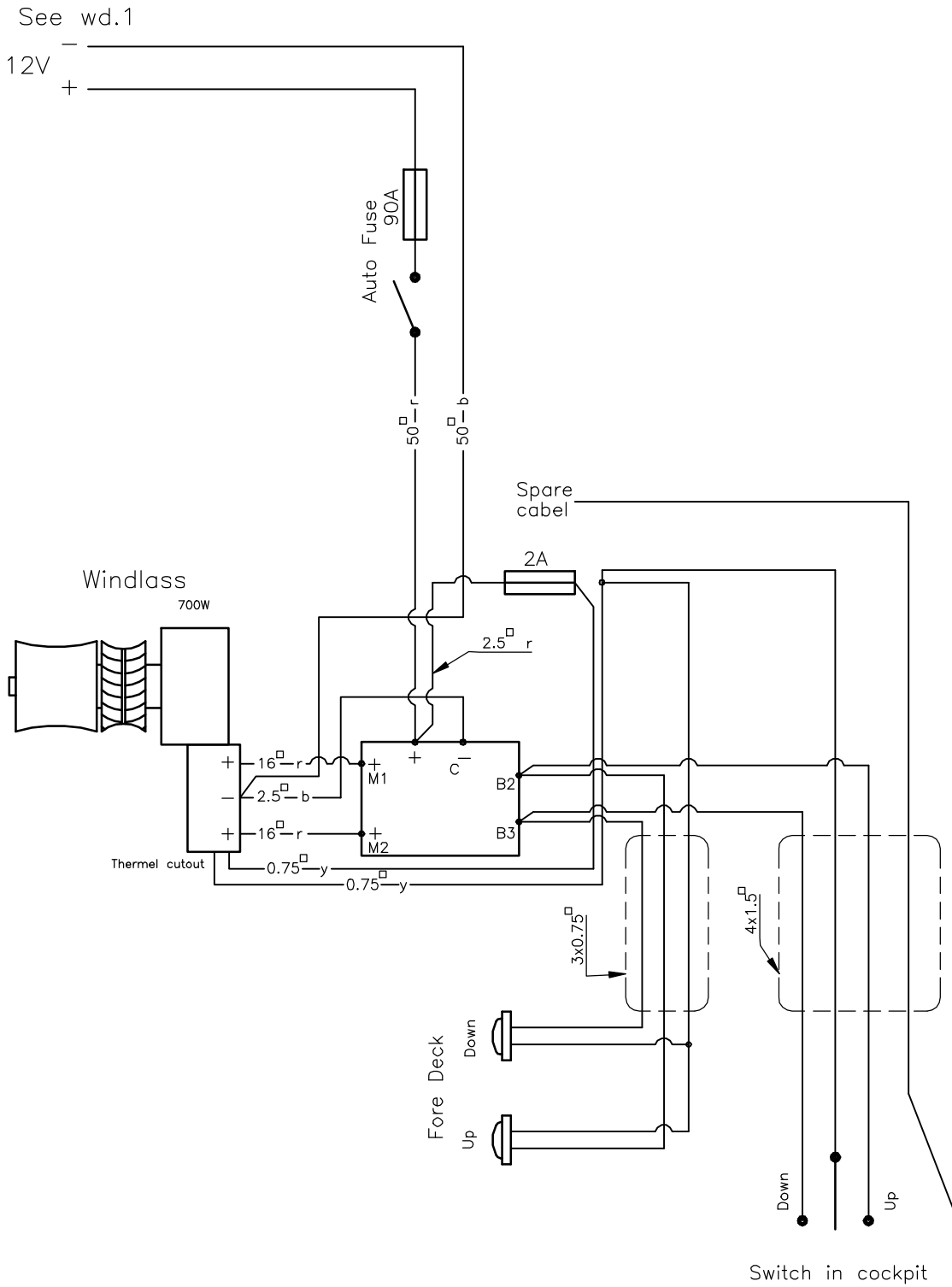

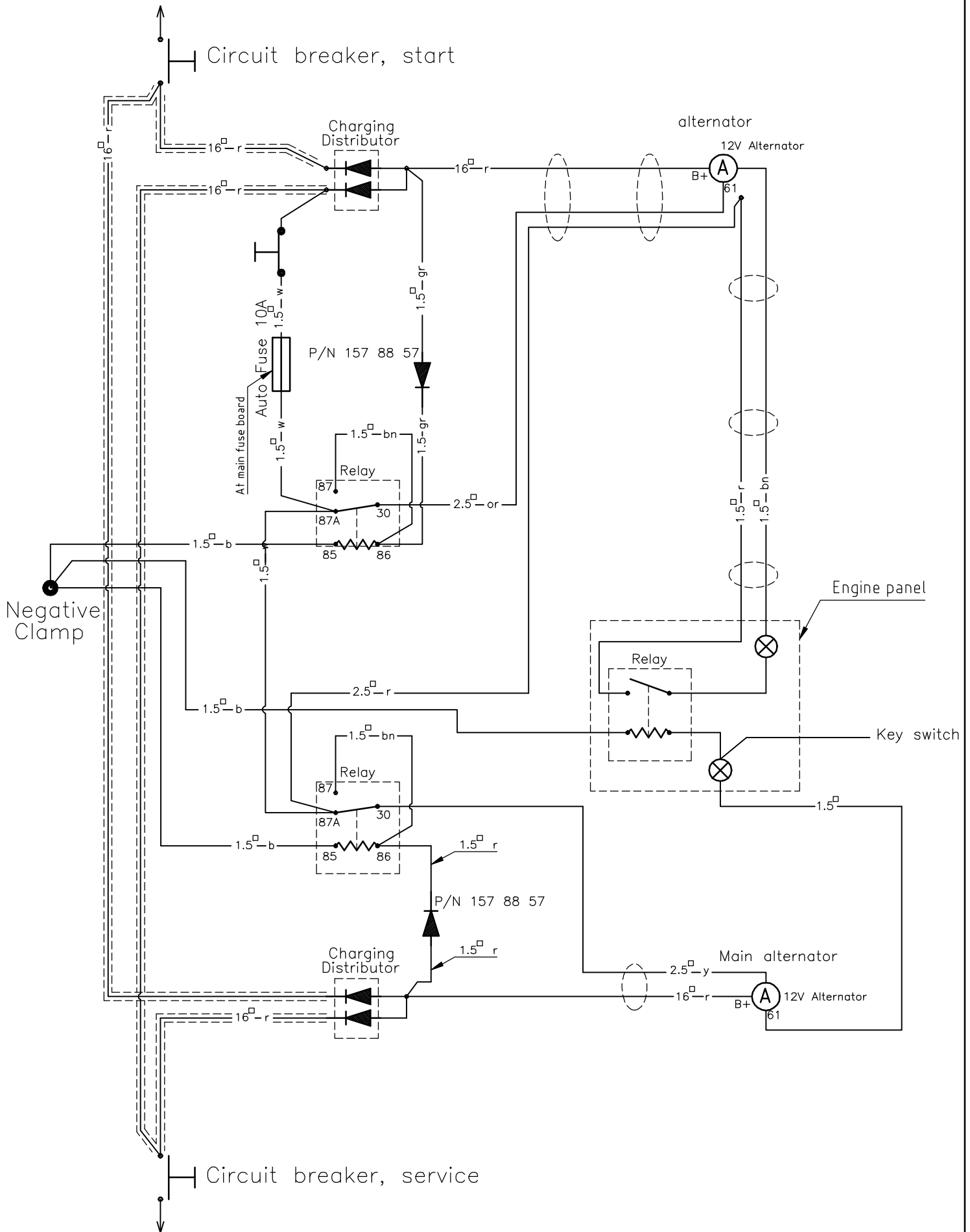

Switches in cockpit

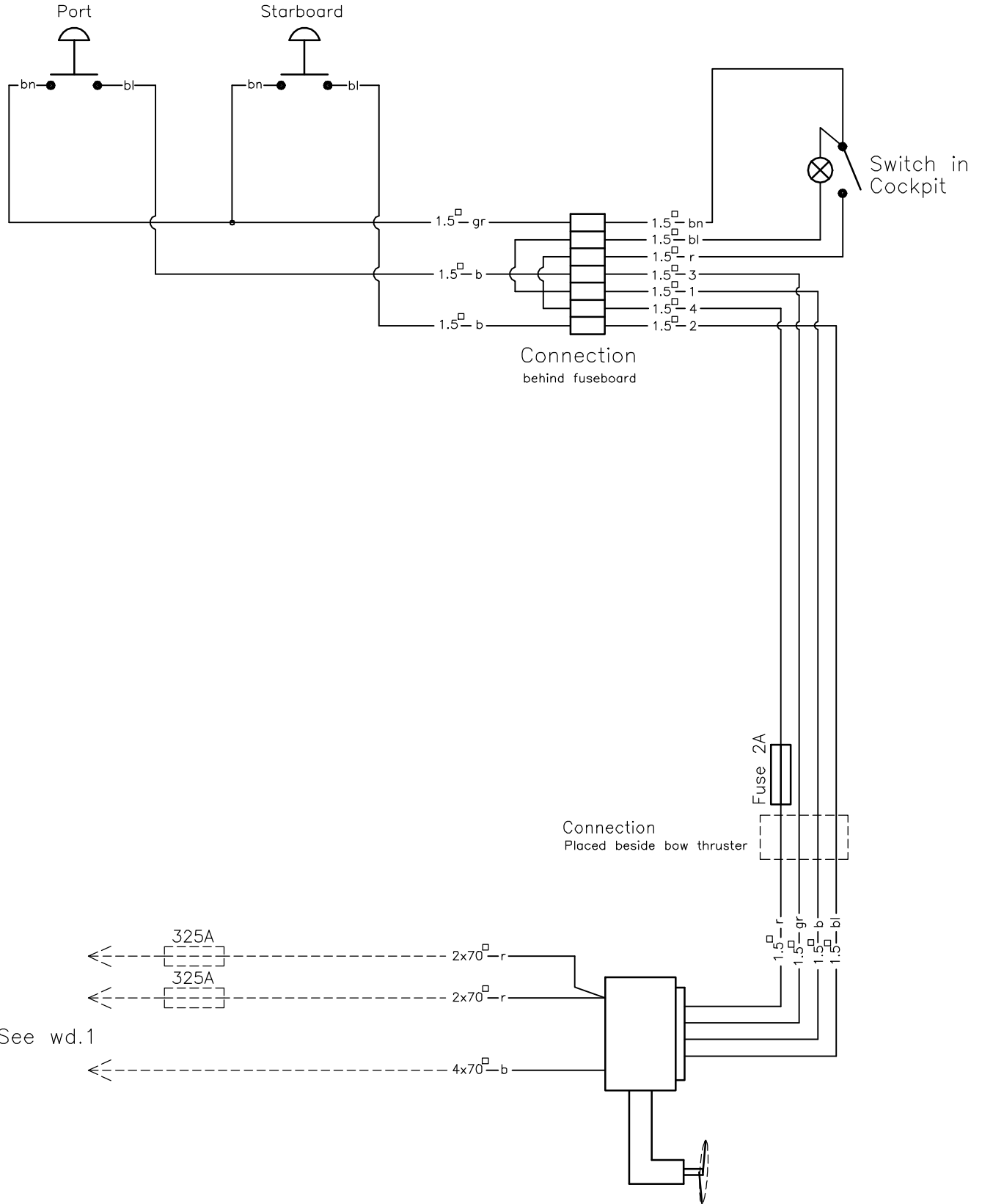



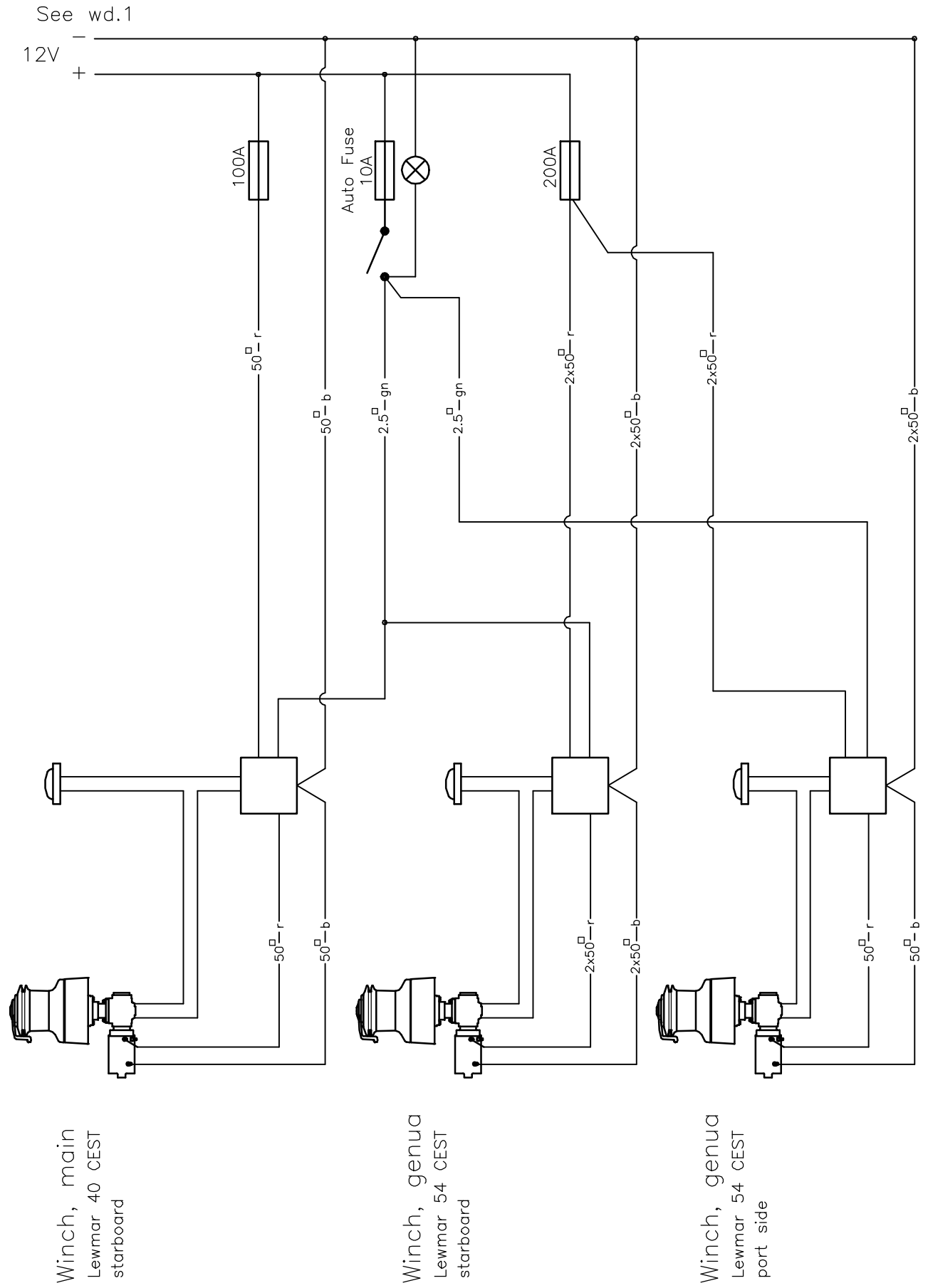

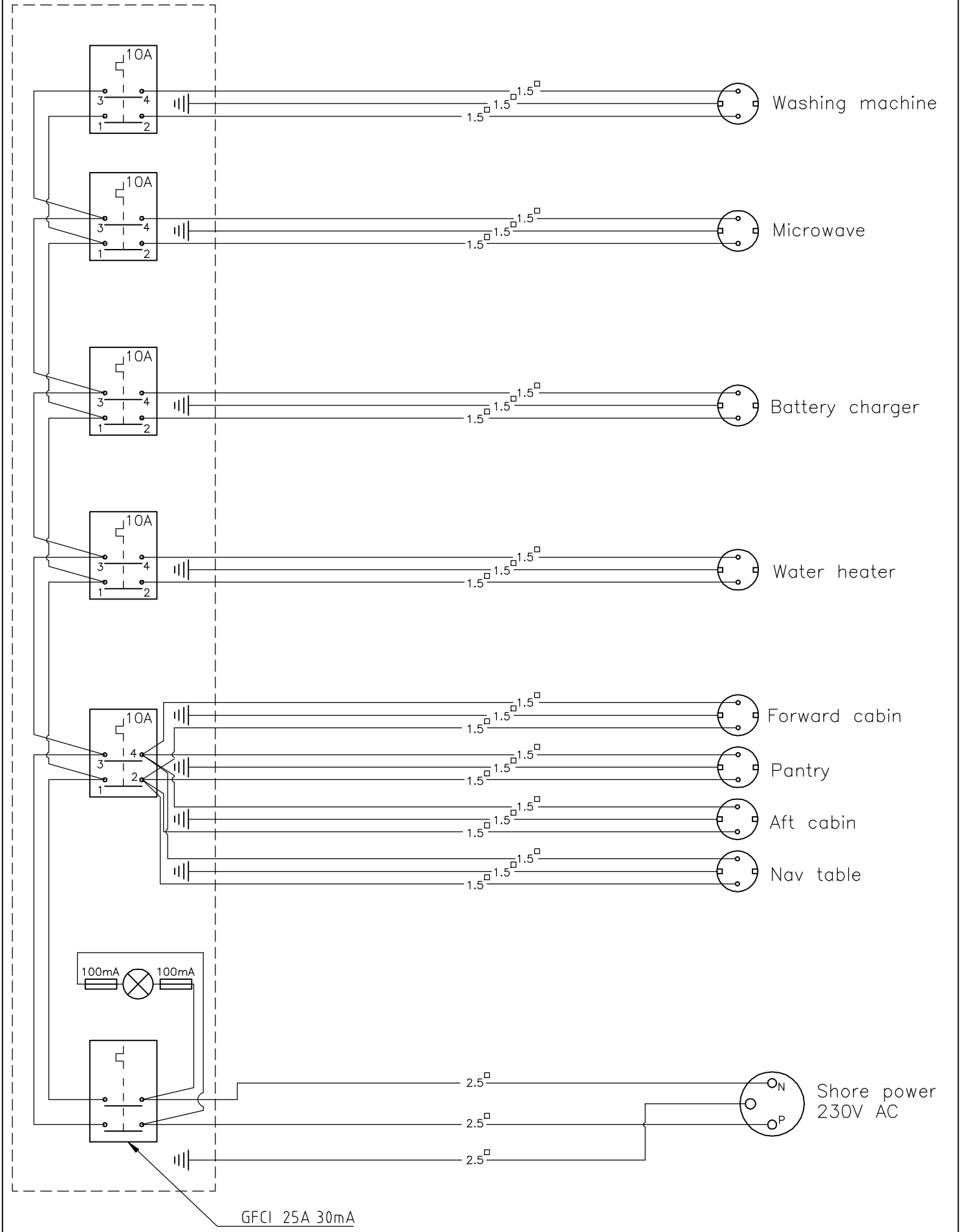

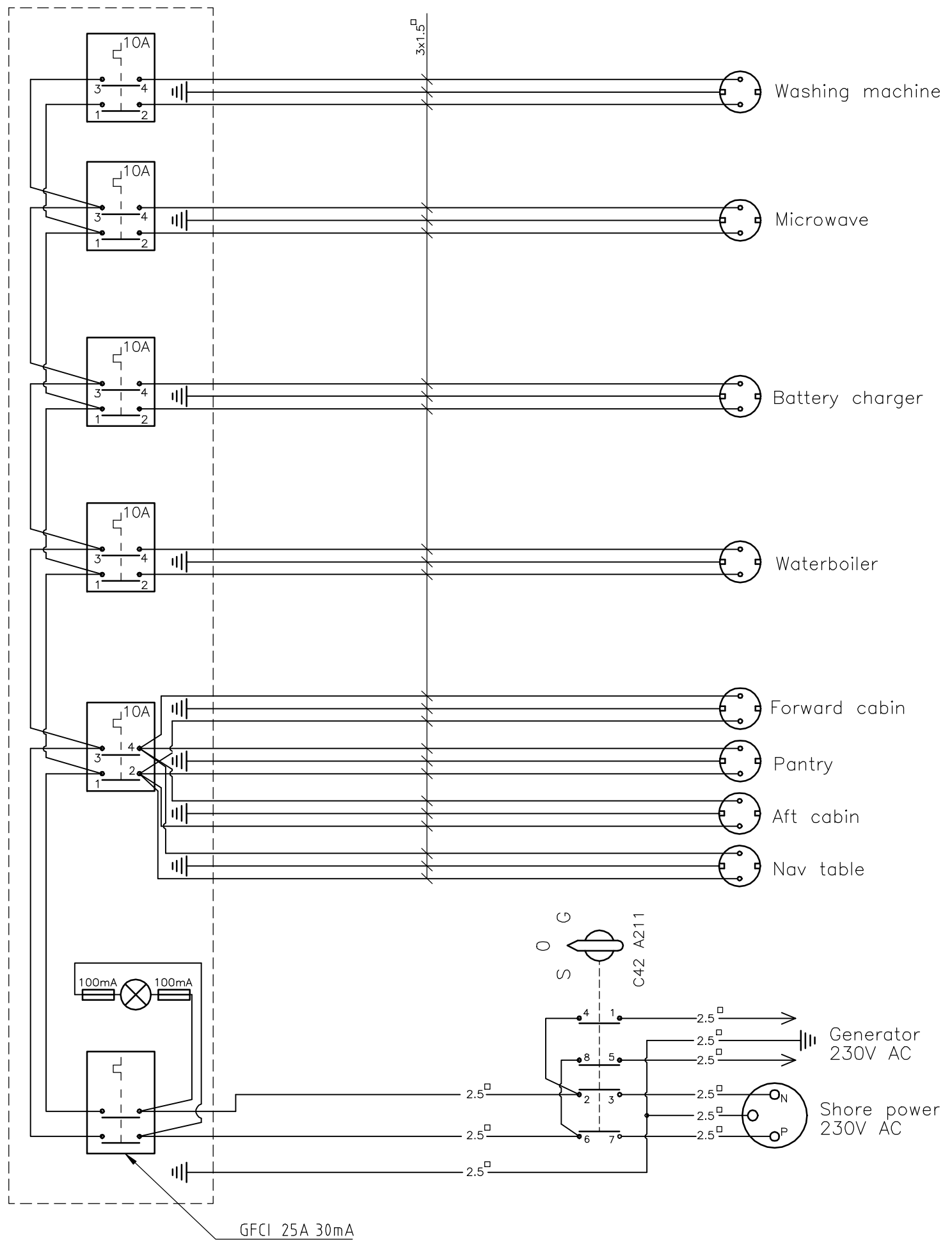

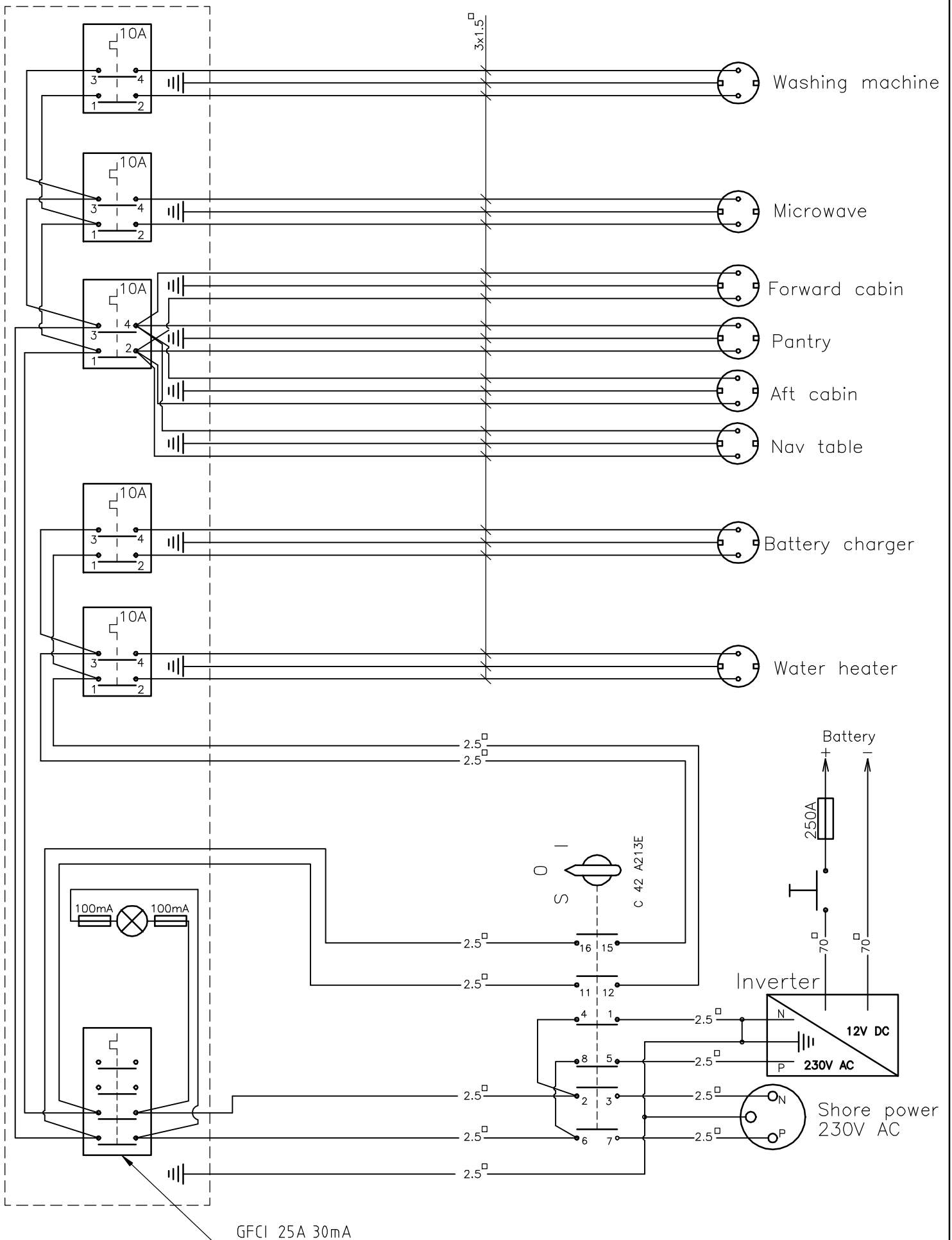

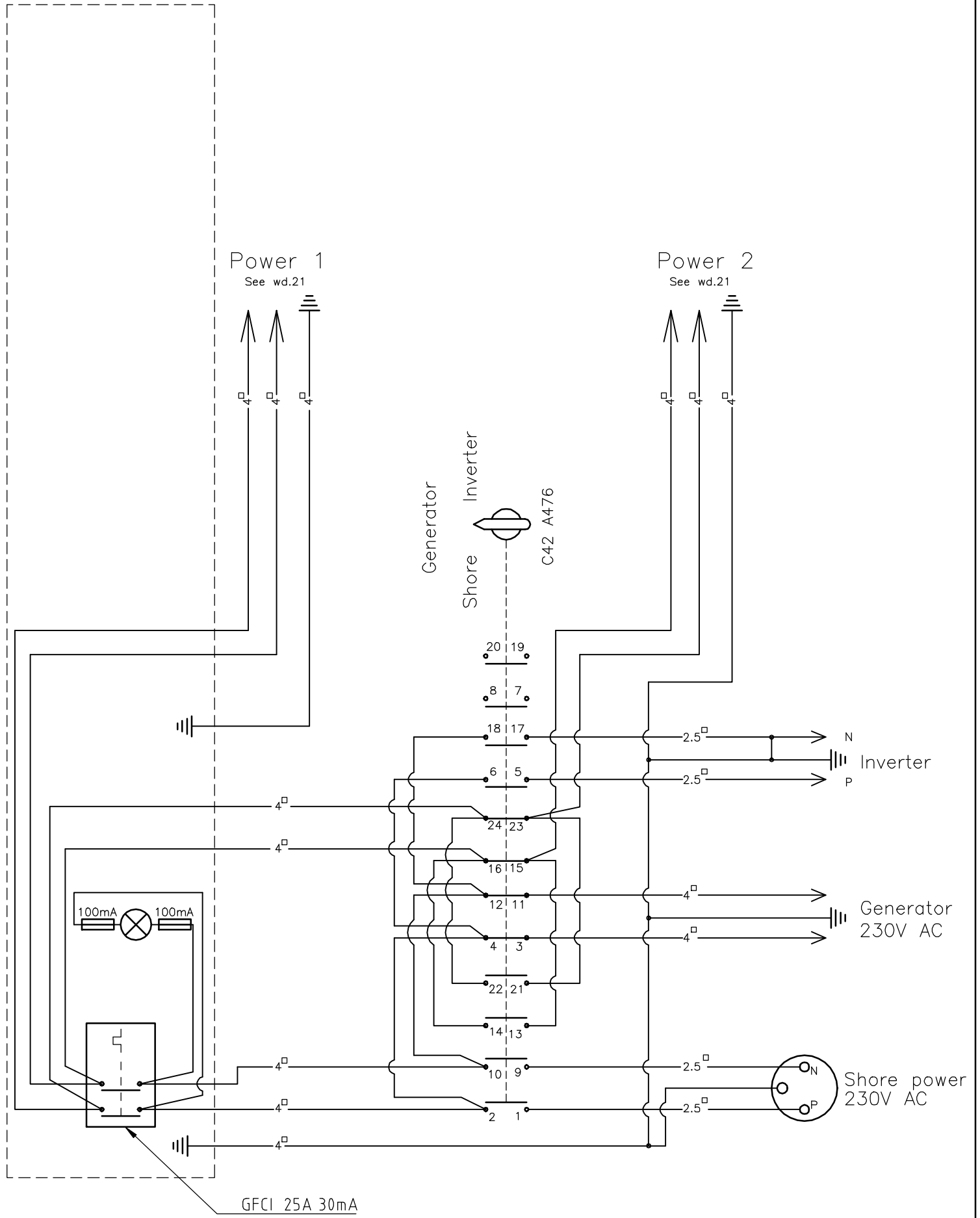

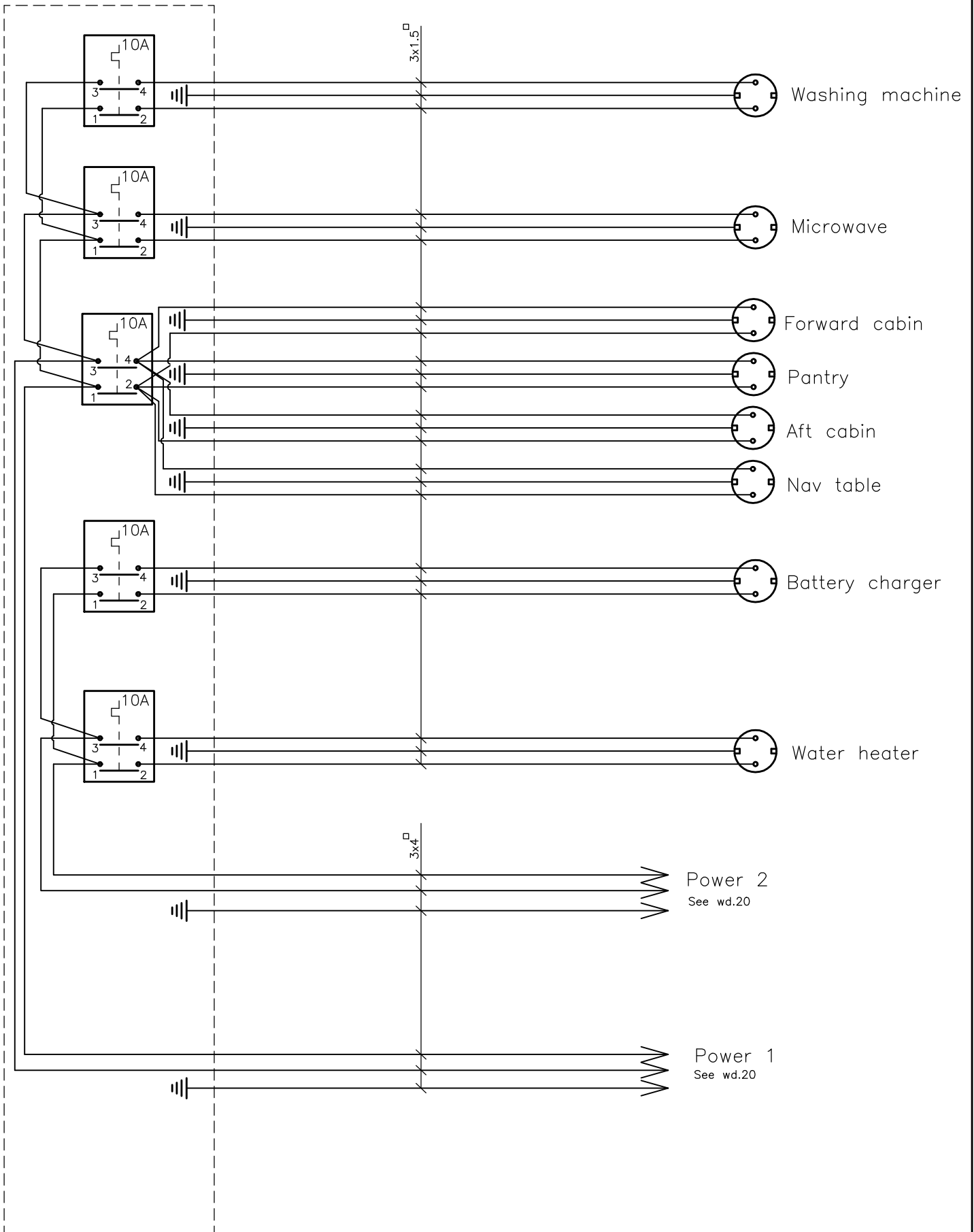

MASCOT TYPE 8660 12/24 CONVERTER

